

INSTALLATION MANUAL SQUARE WITH TRIM FIXED DOWNLIGHT

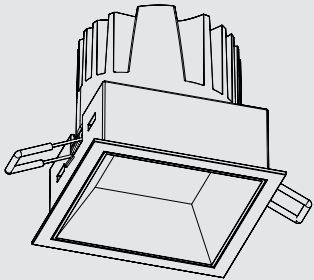

With Trim Square

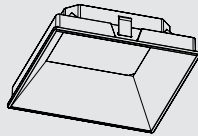

Beveled Trim

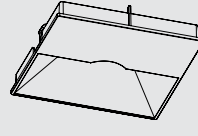

Wallwash Trim



P1 Phillips Screwdriver

Important Notes

- IC fixtures must be used for installations containing insulating materials and must be mounted away from heat producing elements (e.g., HVAC ducts, hot water pipes, radiant heat floors, ovens). Non-IC fixtures cannot be used in these types of applications.
- Non-IC fixtures are intended for free air applications. Do not confine non-IC fixtures with insulation or building materials.
- Install and wire in accordance with national and local electrical codes, by a qualified professional familiar with the construction and operation of luminaire electrical systems and the hazards involved.
- IC fixtures are rated for direct application of spray foam with less than R-21 insulating value or 3 in (76.2 mm) of closed cell spray foam. 95°F (35°C) maximum operating temperature.
- The mud ring shipped with trimless fixtures must be installed to ensure proper installation and to provide structural support.
- Hanger bars can be installed on either side of the fixture.
- Housings, modules, and trims are shipped in separate packages. Install modules and trims per housing labels.
- Installation details with materials other than drywall or plaster, please contact factory for specific instructions.

1. TURN OFF POWER

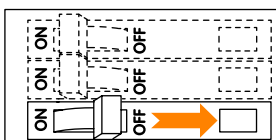

WARNING: Shock Hazard. Serious injury or death may occur. Turn off power before servicing or installing. Wire according to local and national codes. This product shall be installed by a qualified electrician.

2. Install fixture using the hanger bar based on mounting method (Figures 1, 2 and 3). Hanger bars can be installed on either side of the fixture.

- a. Insert hanger bars into hanger bar clamp.
- b. Use hanger bar to secure to structure (notch allows for T-bar installation). Secure wires (not included) to hanger bar (if required).
- c. Hammer barb into stud or secure with mounting screws or nails provided by others.

Notes: For T-bar installation details, please refer to factory for further details according to ceiling type.

Figure 1

NON-IC HOUSING

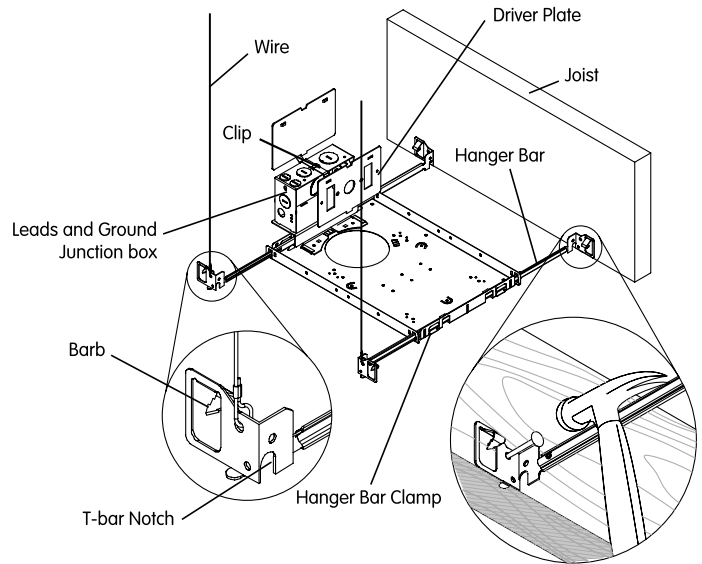

IC HOUSING

Figure 2

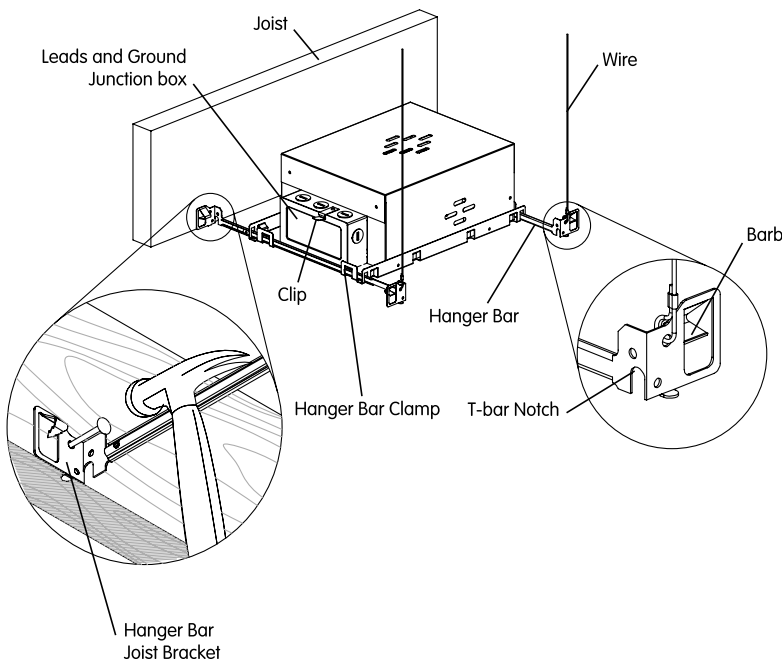

IC AIRTIGHT HOUSING

Figure 3

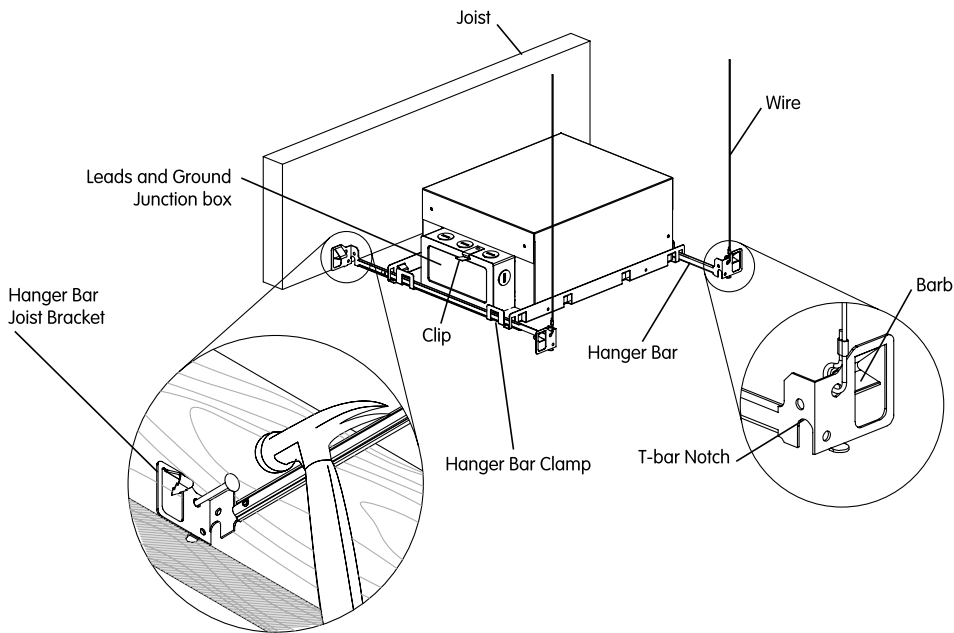

- Run the power line wires into the housing electrical connection box. If required by local electrical code, leave enough wire slack in the housing electrical connection box to allow extending the branch circuit connections through the fixture aperture to facilitate inspection.

Note: for 3in. downlights NM rated cables with snap-in/push-in connectors are used for connection of the driver and the LED module (see Figure 4. for example). A 12" service loop shall be left available outside the housing electrical box allowing for additional cable to be pulled through the connector making the branch circuit connections extend out through the aperture if needed.

Note: Please refer to page 6 & 7 for wiring diagrams.

Figure 4

IC HOUSING G BOX

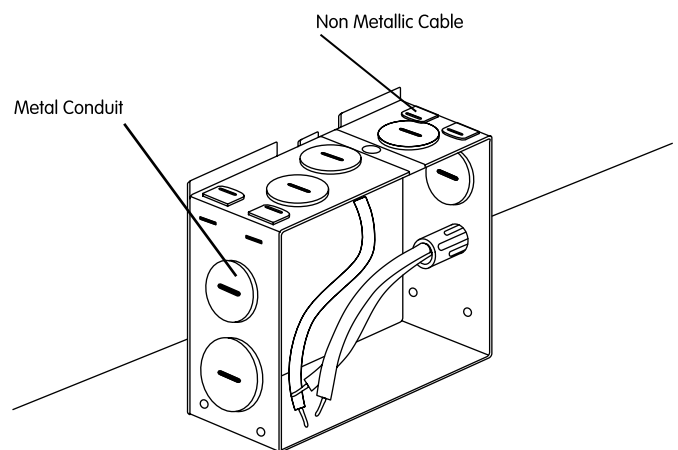

4. For remodel downlights insert the the main electrical feed through the clamp connectors into the driver enclosure and connect it to the driver input wires, according to wiring diagrams on page 6 and 7 driver. A 6" service loop shall be left available inside the driver enclosure allowing for a branch circuit connection if needed.

Connect the driver lead to the branch circuit using appropriate gauge wire nuts. Securely fasten the driver enclosure cover once the connection is done.

REMODEL HOUSING

Figure 5

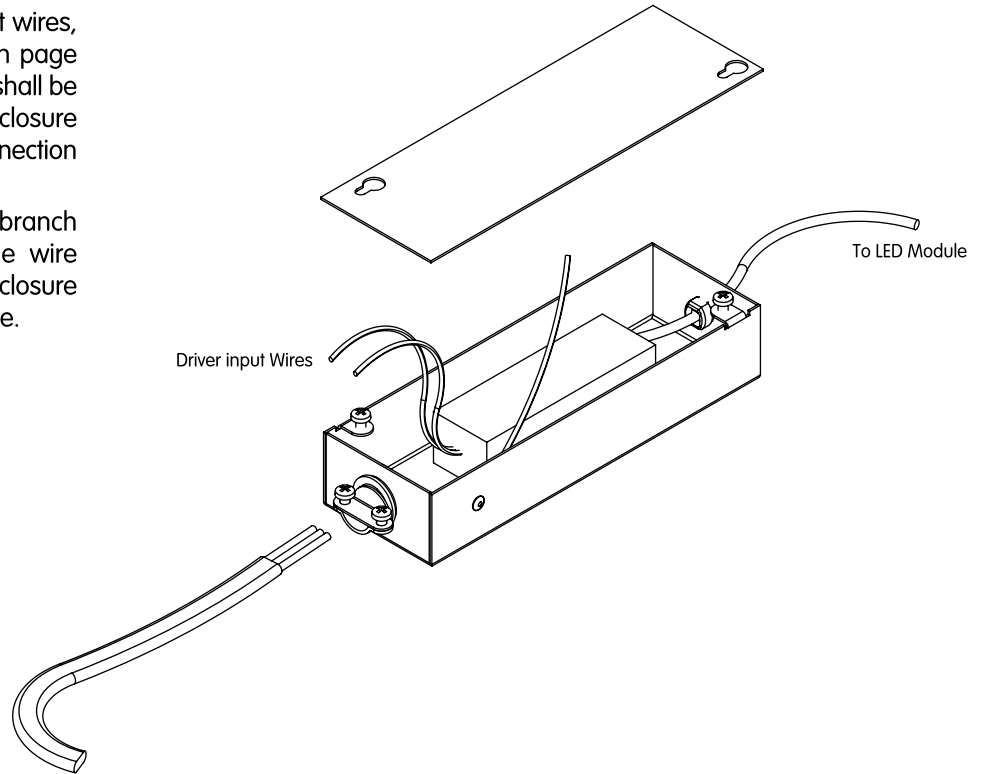

5. After installing the Non-IC or the IC housing Use a rotary cut saw (similar to RotoZip®) to cutout the trim opening. The housing will act as a guide at the top of the cutting bit.

- a. Round diameter: 3 in (75 mm).
- b. Square dimensions: 3 in x 3 in (75 mm x 75 mm).

Figure 6

HOLE CUTOUT

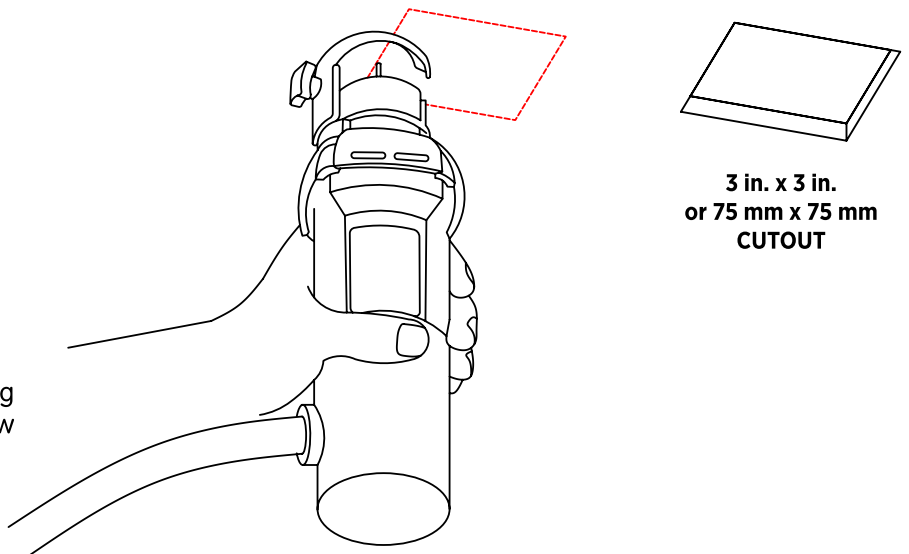

6. Use appropriate cutting bits to cut ceiling material, refer to specific rotary saw manufacturer's recommendations.

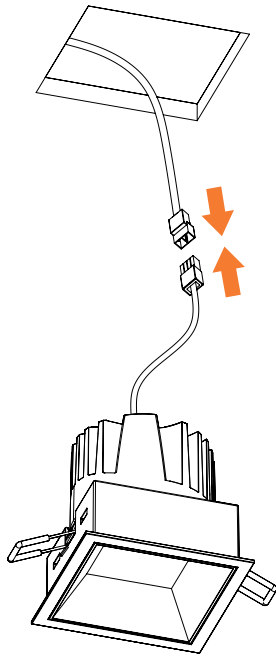

Figure 7

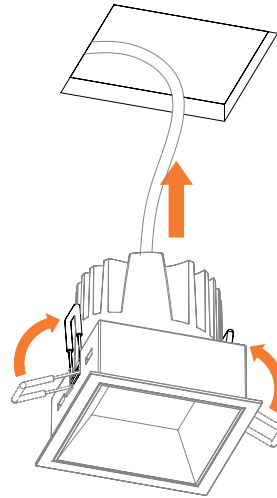

Figure 8

7. Connect LED module to housing. Lock the connector in place. (You will hear a CLICK! Noise)
Note: Connectors are specific to housing / module compatibility.

8. Insert module in Mud-Ring until you hear the spings Click into position.
Note: DO NOT touch the inside of the reflector or the LED.

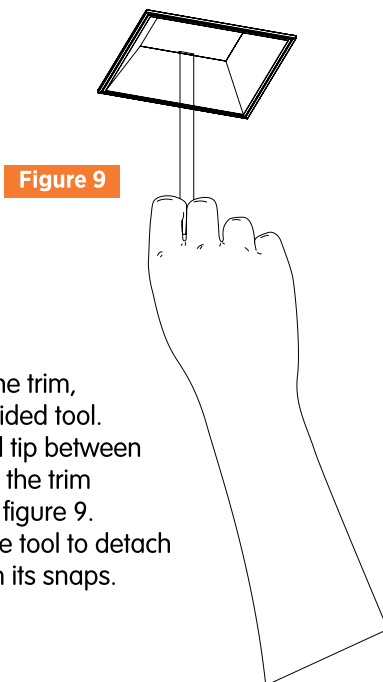

Figure 9

9. To remove the trim, use the provided tool. Slide the tool tip between the lens and the trim as shown in figure 9. Pull down the tool to detach the trim from its snaps.

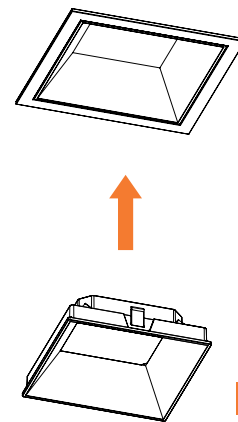
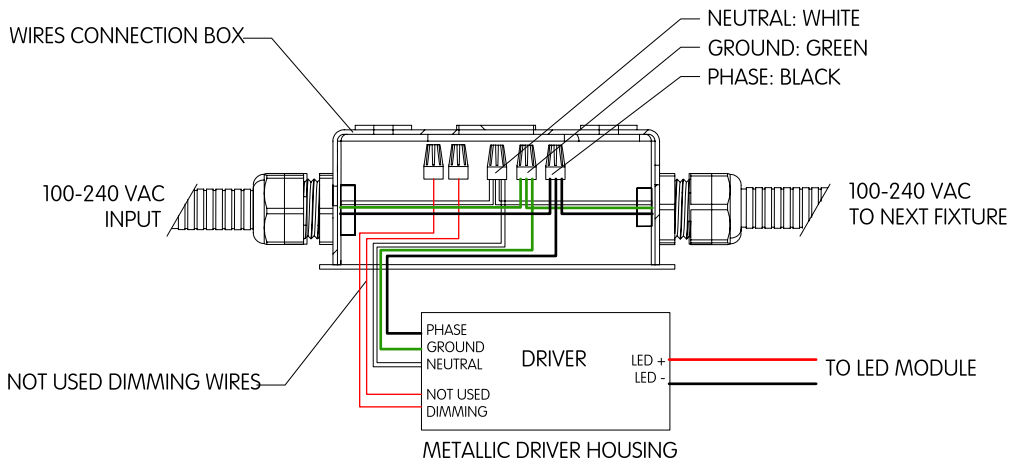

Figure 10

10. To install the trim in place, align the trim snaps with their slots in the downlight module and push in the trim all the way, with both thumbs positioned on the trim, until you hear the snaps "Click" sound.

Wiring Diagrams For Usa, Canada And Mexico

NON-DIMMABLE METALLIC HOUSING DRIVER



- Some of the Non-dimmable drivers used by Bold are 0-10V dimming capable drivers. When such a driver is installed, the controls wires (0-10V+ and 0-10V-) need to be terminated. Failure to do so, will cause the driver and LED module to malfunction and even fail.

NON-DIMMABLE NON-METALLIC HOUSING DRIVER

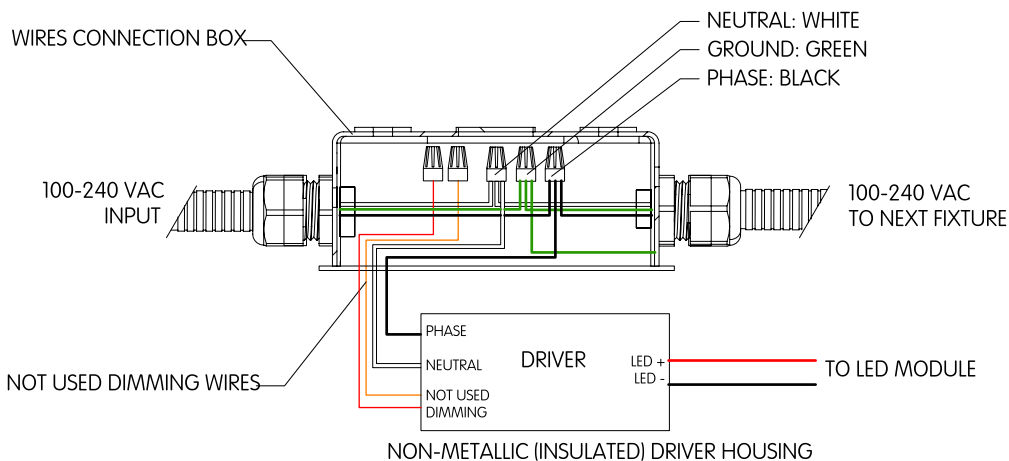

- Some of the drivers used by Bold are Non-Metallic Insulated drivers. Such drivers do not have a ground wire connection. When such drivers are used, connect the Ground wire to the wire connection box as show in the Figure on the left.

Wiring Diagrams For Usa, Canada And Mexico

0-10V DIMMING

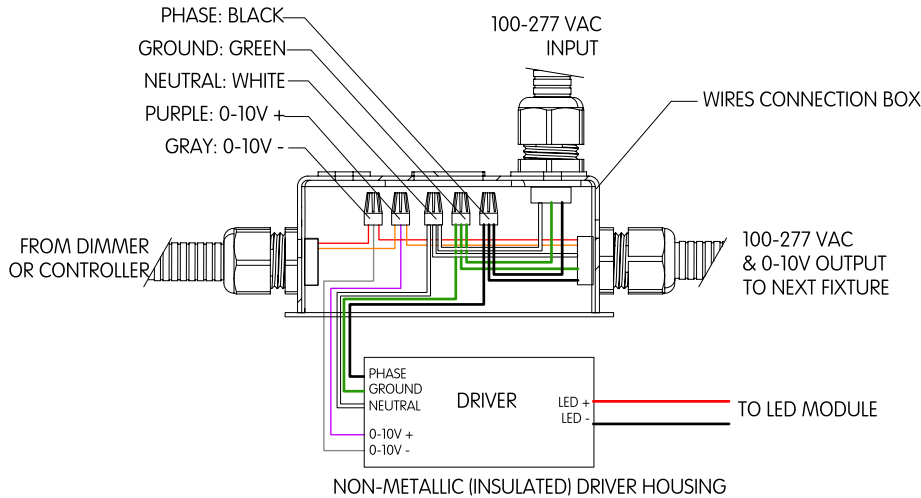

- For 0-10V dimming controller or dimmer switch compatibility, consult the specific driver manufacturer or consult the factory. Check maximum load and number of drivers compatible with installed controllers or dimmer switches.

DALI-DIMMING

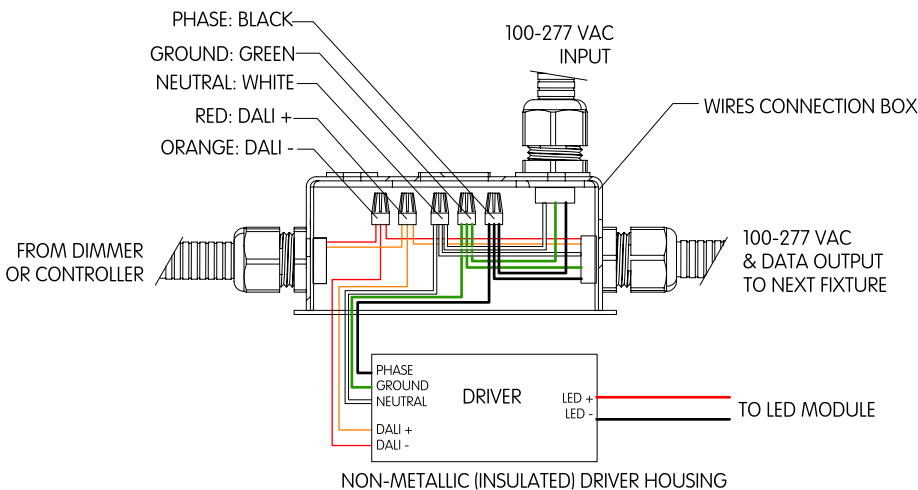

- For DALI dimming controller or dimmer compatibility, consult the specific driver manufacturer or consult the factory for specific DALI protocol versions. Different DALI protocol versions might not operate correctly if not compatible.

PHASE DIMMING (Forward phase, Reverse phase, TRIAC, or other phase dimming).

- For Phase dimming check for compatible dimmers and wiring diagrams with specific driver manufacturer's manuals and specifications. All major phase dimming drivers manufacturers have available list of compatible and recommended dimmers.

Notes: Bold Lighting reserves the right to make technical changes without notice.